

# Thermostats

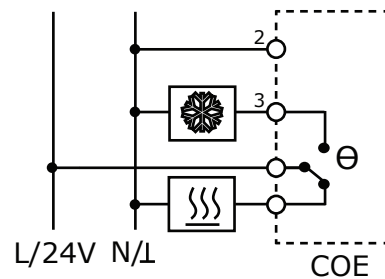
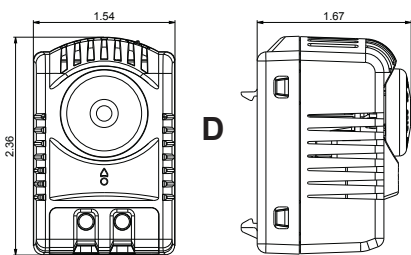
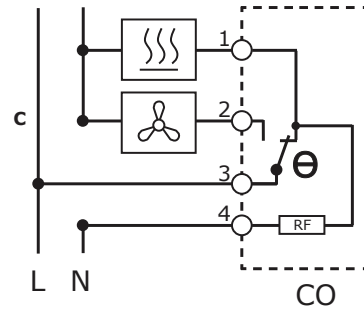
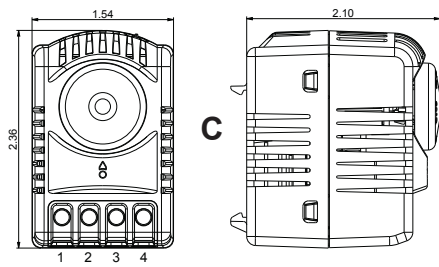
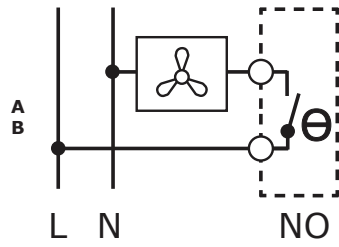
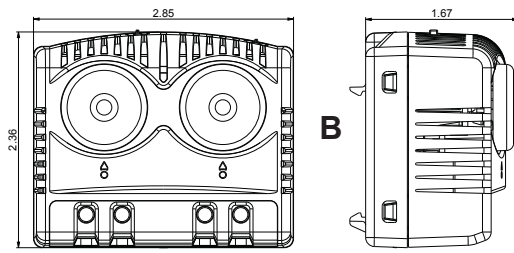
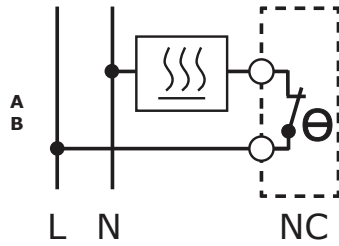
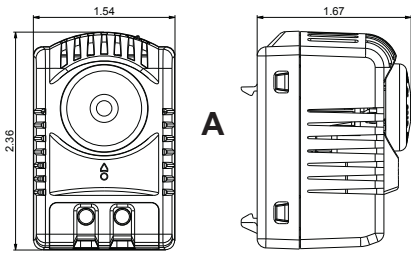

### Safety Information

This component must be installed/serviced by qualified personnel complying with the relevant safety regulations in force and in accordance with the wiring diagram shown on the housing and represented in this manual. Ensure manuals are kept in a secure place accessible to servicing/installing personnel.

### Device Description

This device has been designed specifically for cabinet temperature control.

### Manually Adjustable Thermostat

Knob Color	With temperature rising, at the set temperature:
Red NC	Breaks Contact
Blue NO	Makes Contact
White CO	Breaks Contact 3 to 1 Makes Contact 3 to 2
White COE	Electronic Adjustable Thermostat

### Installation

The device has been designed for installation on a DIN EN 60715 compliant standard rail. Preferably, it should be installed in the upper part of the cabinet with maximum separation from heat generating components. Thermostat's ventilation slots must not be covered.

Switching Capacity		pf 0.95	pf 0.75
AC	max. 250 V 50/60 Hz	A/B	16 A
		C	10 A
DC	A/B/C	max. 72 V DC / max. 30 W	
	D	24 V DC, 16 A resistive load	

	A / B	C	D
<b>Hysteresis</b>	7K ±3K	7K	±3K / 5%
<b>Switching Tolerance</b>	±4K	±3K	±3K / 5%

1 + 2 Installation



3 + 4 Removal

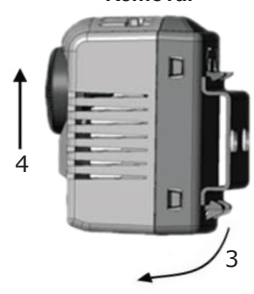

### Control Range

A	SCE-TEMNC	14 – 176°F
	SCE-TEMNO	14 – 176°F
B	SCE-TEMND	14 – 176°F
C	SCE-CTEM	32 – 140°F
D	SCE-TEMEVDC	14 – 176°F

### Operating/Storage Temperature:

- A/B: -49°F – 248°F
- C: 32°F – 140°F
- D: -13°F – 158°F

Connection: 0.5 – 2.5mm<sup>2</sup> / 14 – 20 AWG

Housing Material: Plastic UL94V-2

