

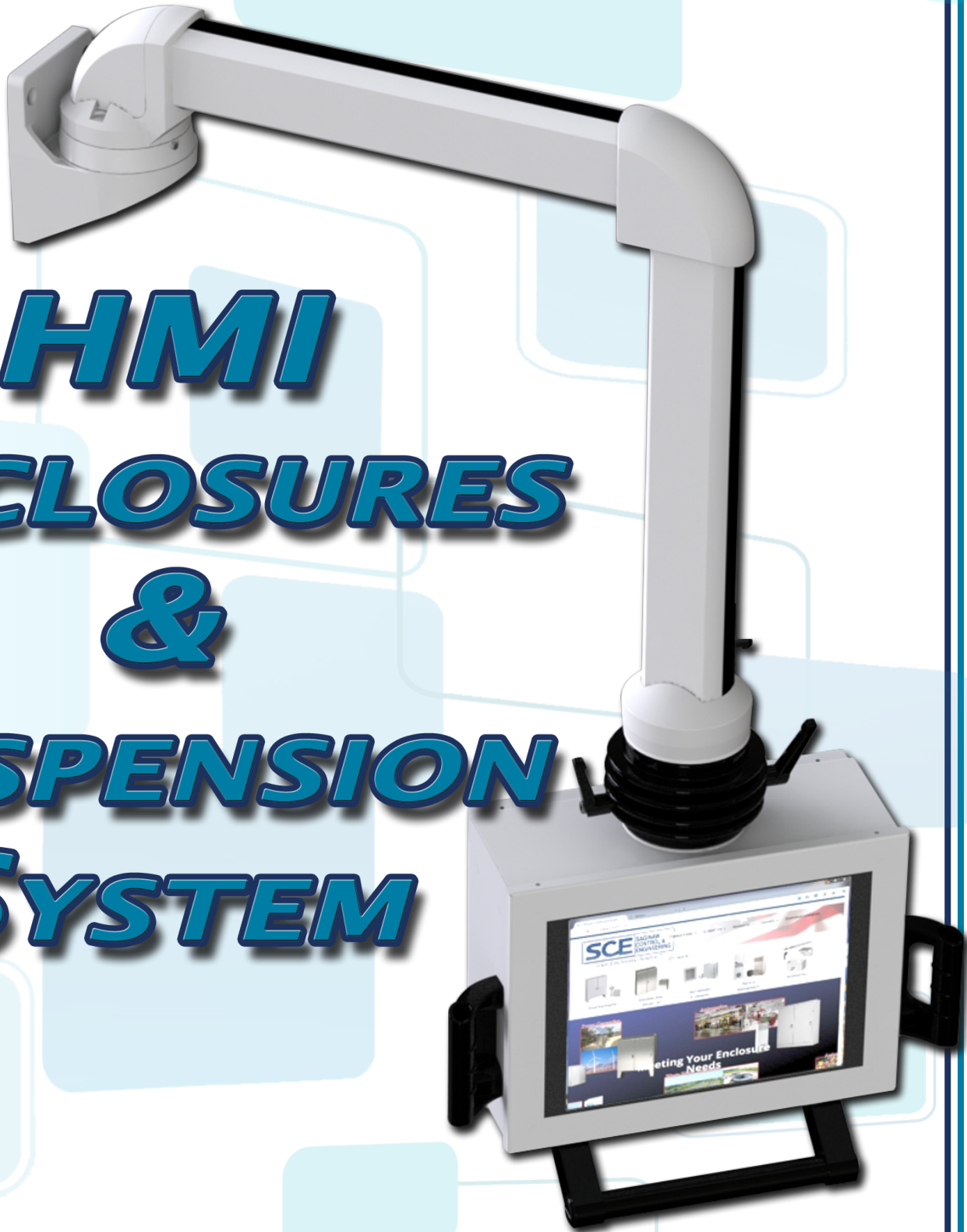

Your Enclosure Source®

HMI ENCLOSURES & SUSPENSION SYSTEM



HMI ENCLOSURES

Designed specifically to house Human-Machine Interfaces (HMI) and electronic controls, instruments, and components. Optional pull handles and keyboard shelf available.

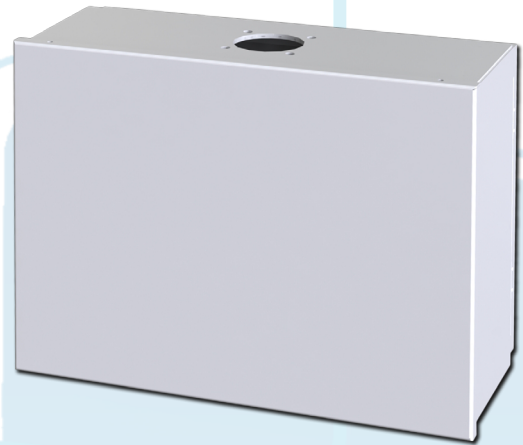

Product Attributes:

- Removable front cover for easy installation of cutouts, HMI, and components.
- Reinforced with mounting provisions for suspension or pedestal mounting.
- Concealed hinge access door with provisions for sub-panel.
- Black quarter turn latches that are opened and closed with a screwdriver, optional tamper-resistant latches available.
- Available in RAL 7035 gray powder coated steel or stainless steel.
- Nema Type 3R, 4, 12 & 13
- UL Listed Type 3R, 4 & 12
- CSA Approved Type 3R, 4 & 12
- SS: Type 3R, 4, 4X & 12



HMI ENCLOSURES

ENCLOSURE PRODUCT CODE C2				SUB-PANEL (P3)		
Catalog No.	Height (A)	Width (B)	Depth (C)	Catalog No.	Panel Height (D)	Panel Width (E)
SCE-12HMI1606LP	12.00	16.00	6.00	SCE-12P10	10.75	8.88
SCE-12HMI1610LP	12.00	16.00	10.00	SCE-12P10	10.75	8.88
SCE-14HMI1806LP	14.00	18.00	6.00	SCE-14P12	12.75	10.88
SCE-14HMI1810LP	14.00	18.00	10.00	SCE-14P12	12.75	10.88
SCE-16HMI2006LP	16.00	20.00	6.00	SCE-16P14	14.75	12.88
SCE-16HMI2010LP	16.00	20.00	10.00	SCE-16P14	14.75	12.88
SCE-20HMI2406LP	20.00	24.00	6.00	SCE-20P18HMI	18.75	16.88
SCE-20HMI2410LP	20.00	24.00	10.00	SCE-20P18HMI	18.75	16.88

HMI ACCESSORIES

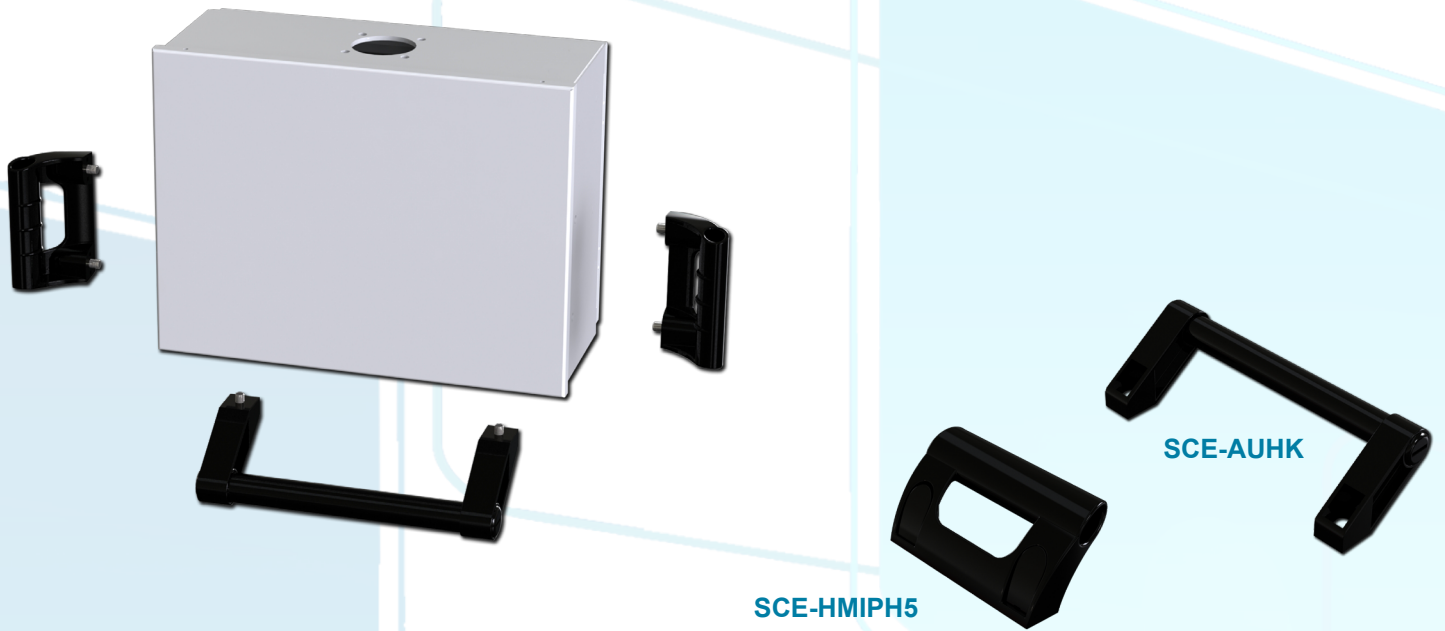

HMI PULL HANDLES

Catalog No.	Height (A)	Width (B)	Depth (C)	QTY per Kit	Product Code
SCE-HMIPH5	5.28	2.57	2.84	1	P2
SCE-AUHK	12.00	4.27	3.15	1	P2

HMI KEYBOARD SHELVES

Catalog No.	Height (A)	Width (B)	Depth (C)	Finish	Product Code
SCE-HMIKBS	4.52	18.00	13.69	Black Texture	P2
SCE-HMIKBSSS	4.52	18.00	13.69	Stainless Steel	P2

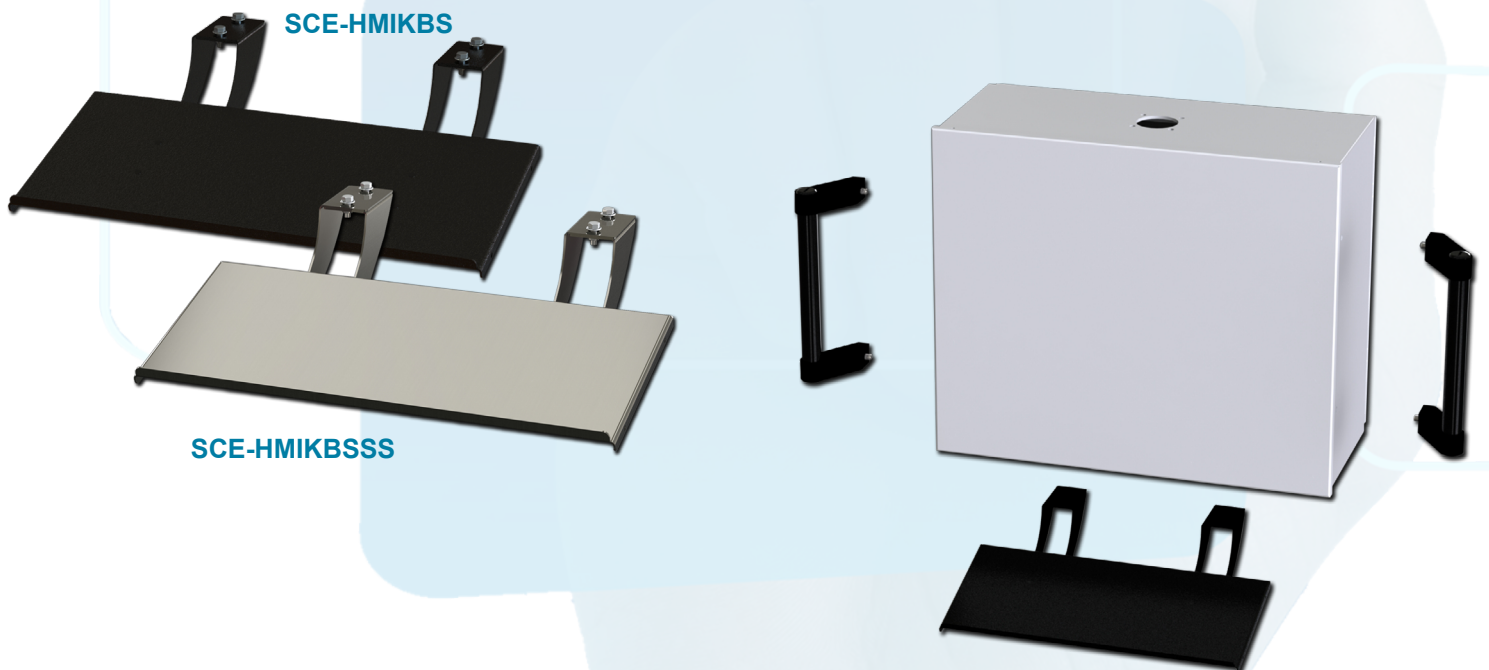

SUSPENSION SYSTEM

Designed for use with the SCE HMI enclosures, to allow operators to easily move or position an HMI to an ergonomic and comfortable working position. Made of heavy-duty, reliable construction. Suspension Systems can be assembled in a multitude of configurations that allow for machine mount, wall mount, top mount, and floor mount options.

Product Attributes:

- Cast aluminum couplings.
- Extruded aluminum tubes (6060T66).
- Rotating couplings have adjustable tensioner brakes to control movement while in use.
- Rigid, durable bearings in all rotating couplings withstand the stress of continuous use.
- Open or closed tube design.
- Open tube allows for easy access to lay in wiring, with easy to install push fit rubber cover.
- Closed tube acts as conduit for feeding wiring.
- Removable access covers on all couplings with 90 degree turn.
- Hardware and gasket included for installation of coupling to tube.

LOAD DIAGRAMS

WITH INTERMEDIATE JOINT

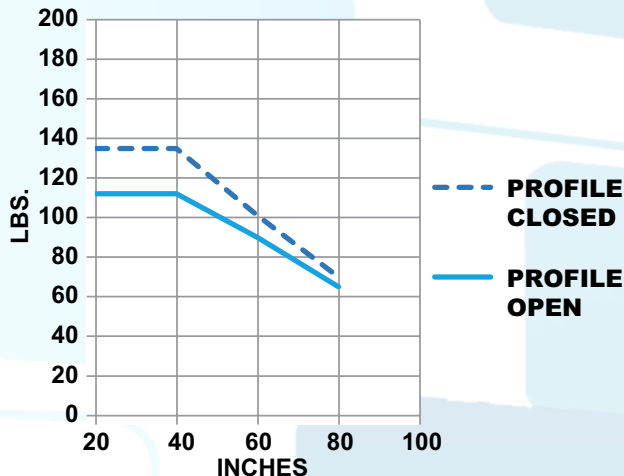

With Intermediate Joint - Max. Tube Length:

Profile Closed:

- 60" distance between wall hinge, top mounted joint and intermediate joint
- or -
• 60" distance between angle and intermediate joint

Complete length max. 80"

Profile Open:

- 40" distance between wall hinge, top mounted joint and intermediate joint
- or -
• 40" distance between angle and intermediate joint

Complete length max. 80"

WITHOUT INTERMEDIATE JOINT

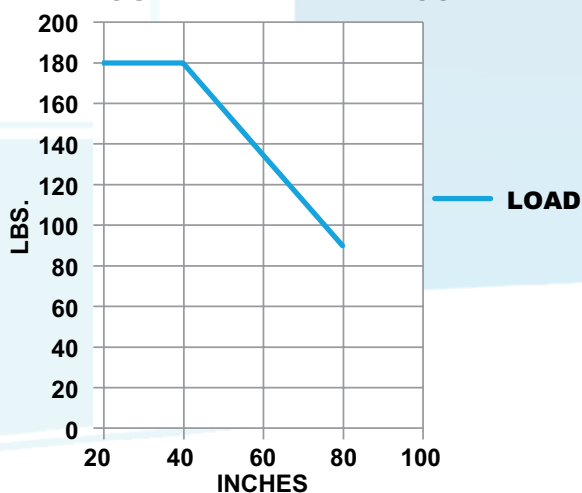

SUSPENSION SYSTEM

POSSIBLE SUSPENSION SYSTEM CONFIGURATIONS

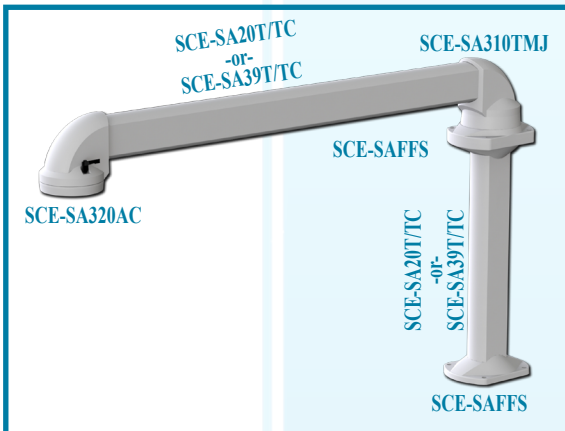
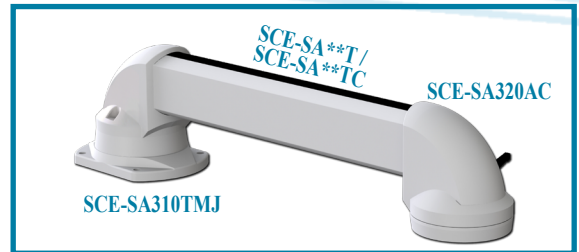
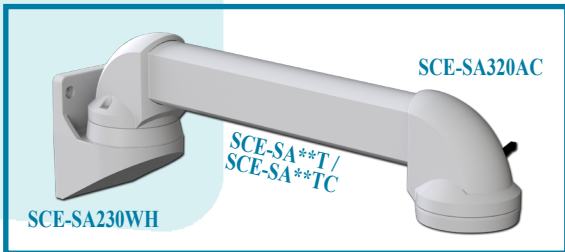
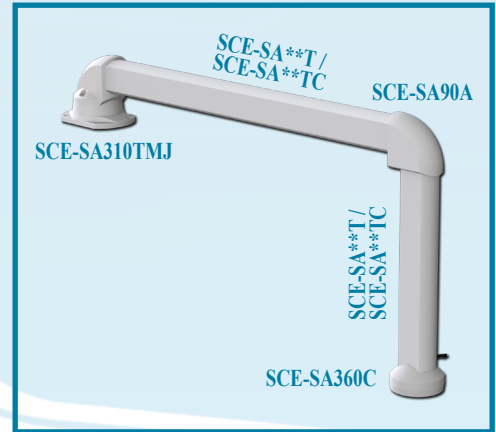
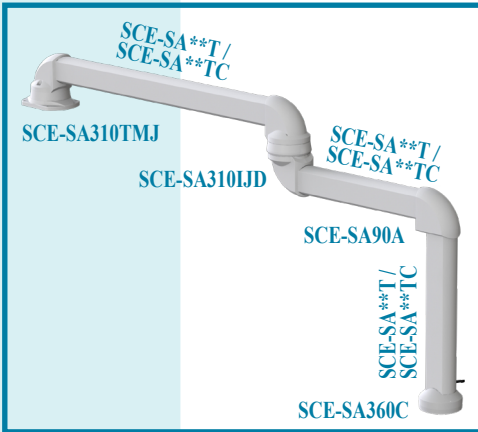
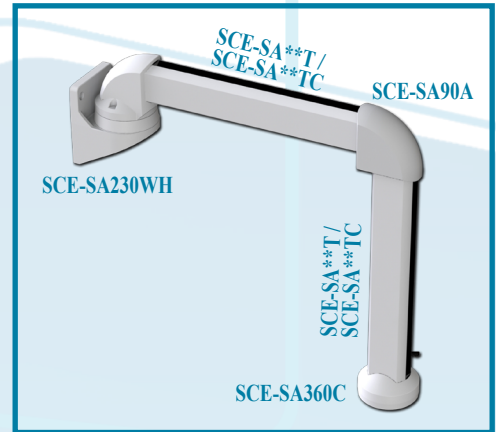
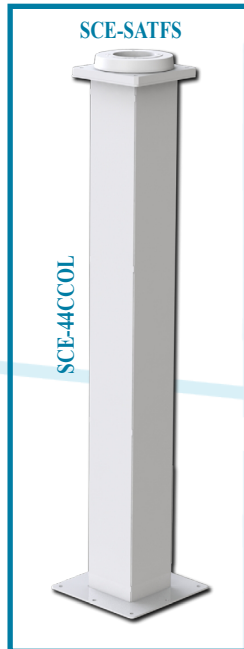
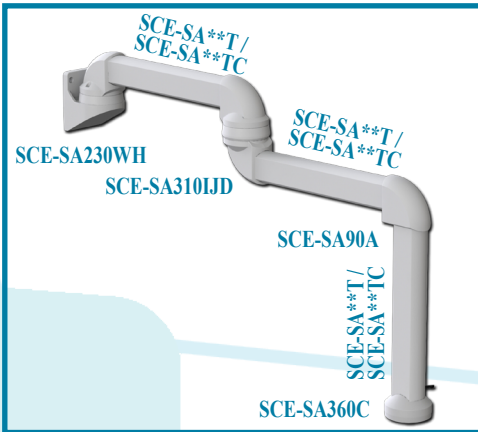

COMBINE TO MAKE SWIVEL & TILT OPTION:

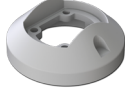

SUSPENSION SYSTEM

Catalog No.	Description	Height (A)	Width (B)	Depth (C)	
SCE-SA45IA	Inclining Adapter	4.33	9.29	6.38	
SCE-SA320AC	Angle Coupling, 320 Swivel	5.89	5.08	5.08	
SCE-SAFC	Fixed Coupling	1.85	5.08	5.08	
SCE-SA360C	Coupling, 360 Swivel	2.72	5.08	5.08	
SCE-SATFS	Turnable Foot Stand, 360 Swivel	1.34	5.75	5.75	
SCE-SAFFS	Floor Stand Fixed	1.93	7.68	5.71	
SCE-SA90A	Angle 90 DEG	5.35	5.35	3.27	
SCE-SA230WH	Wall Hinge, 230 Swivel	9.94	5.43	6.83	
SCE-SA310IJ	Intermediate Joint, 310 Swivel	11.46	5.35	6.34	
SCE-SA310IJD	Intermediate Joint, 310 Swivel Down Drop	11.46	5.35	6.34	
SCE-SA310TMJ	Top Mounted Joint, 310 Swivel	7.17	5.71	7.68	
SCE-SA79TC	Closed Tube Suspension Profile	78.74	2.56	3.54	
SCE-SA39TC	Closed Tube Suspension Profile	39.37	2.56	3.54	
SCE-SA20TC	Closed Tube Suspension Profile	19.69	2.56	3.54	
SCE-SA79T	Open Tube Suspension Profile	78.74	2.56	3.54	
SCE-SA39T	Open Tube Suspension Profile	39.37	2.56	3.54	
SCE-SA20T	Open Tube Suspension Profile	19.69	2.56	3.54	

Corporate Office

95 Midland Rd, Saginaw, MI 48638
 (989) 799-6871 • Fax (989) 799-4524 • (800) 234-6871
 www.saginawcontrol.com • E-mail: sce@saginawcontrol.com

Distribution Centers

Aurora Industrial Park
 40 Aurora Industrial Parkway
 Aurora, Ohio 44202
 Phone (330) 995-9800
 Fax (330) 995-9802
 Toll Free (888) 216-9803
 Aurora@saginawcontrol.com

Kenosha Industrial Park
 5110 70th Avenue
 Kenosha, Wisconsin 53144
 Phone (262) 657-4700
 Fax (262) 657-4774
 Toll Free (800) 345-2080
 Kenosha@saginawcontrol.com

Roane Regional Business & Technology Park
 220 Sam Rayburn Parkway
 Lenoir City, Tennessee 37771
 Phone (865) 717-4861
 Fax (865) 717-4924
 Toll Free (866) 710-4717
 LC@saginawcontrol.com

Tahoe Reno Industrial Center
 795 Denmark Drive
 McCarran, Nevada 89434
 Phone (775) 343-1834
 Fax (775) 343-1838
 Toll Free (877) 493-1834
 Reno@saginawcontrol.com

Tulsa Distribution Center
 2725 N David Patrick Ave E
 Tulsa, Oklahoma 74116
 Phone (918) 949-9766
 Fax (918) 437-3477
 Toll Free (833) 671-1838
 Tulsa@saginawcontrol.com